



APPLIANCES RANGE 2017-18



ABOUT US

RR Global, a part of Ram Ratna Group, is a leading conglomerate in the Electrical industry and a global manufacturer. We collectively engineer every electrical need of a modern society through the four business lines, we operate in :

- **Wires and Cables (RR Kabel)**
- **Winding Wires (RR Shramik)**
- **Electrical Consumer Durables and Accessories (RR Electric)**
- **Electro-Mechanical Multilevel Car Park Solutions (RR Parkon)**

The group has a turnover of ₹ 4300 Cr. We proudly lead the way in all aspects of innovative, well-engineered solutions that are integrated into the highest quality products. A conglomerate with many group companies, Ram Ratna Group is headquartered in Mumbai, with corporate office in Baroda and has presence across India and abroad with 1 plant each in Bangladesh, Nepal and Middle East and 9 world-class manufacturing facilities in India.

ABOUT RR ELECTRIC

Ram Ratna Electricals Limited (RREL) is subsidiary of RR Global which is engaged in the production and distribution of the following products under the brand name RR Electric.

The products on offer are sleek designed and features, that compare with the best. Superior performance and of course the safety and reliability that have been the hallmark of RR over the years. It's our way of making life just a little more comfortable for the Indian consumer.

Product range comprises of:

Fans:

It has a wide range for both domestic and industrial customers. The range encompasses of the entire spectrum from ceiling, wall, table fans, pedestal, domestic exhaust fans and industrial fans.

RR Electricals is proud to launch **Super Power Saver 28W Ceiling Fan** under the brand name "**MH Classic**"- **India's Lowest Wattage Branded Ceiling Fan**. This Super Power Saver Ceiling Fan comes with **service value of 8.0 plus**. It saves 60% power compared to a conventional fan and hence your Fan becomes FREE in 9 months**.

Appliances:

Appliances comprise of a range of Water Heaters, Electric Irons, Immersion Rods, Room Heaters, Room Coolers etc.

Switches:

It has a wide range for both domestic and industrial customers. Launched the first of its kind "Design it Yourself" switches which are very well received and appreciated by the market. We have also designed and launched one of its kind in India - a 3 plate switches with transparent options in them.

LED Lighting:

It covers a comprehensive range of LED Lighting for domestic, industrial and outdoor applications. The product range comprises of LED Bulbs, Tube lights, Panel lights, Downlights, Flood lights, Hi-Bay, Bollard lights, Street Lights along with Poles etc. The product mix meets the requirements of both B2B and B2C customer for the value of money. Our products come with warranty and are backed by an efficient customer service team. We constantly strive towards innovation and improvisation of our various products and offerings.



Indulge in *Refreshment*

Cuisiner Tankless Electric Water Heater

Frission Digital Water Heater

Supremus GLS Water Heater

Supremus DLX Water Heater

Supremus Water Heater

Ardor - Instant Water Heater

Instant Gas Water Heater

CUISINER

Tankless Electric Water Heater

FEATURES:

- High strength ABS splash proof casing.
- Cast aluminum heating element.
- Compact appearance and continuous supply of hot water.
- Easy installation, rationale structure, easy wire connection.
- Easy operation, automatic constant temperature & memory.
- Touch screen, LED digital display of water temperature.
- Overheat & dry-heating protection.
- Built-in pressure relief valve to prevent explosion.

TECHNICAL SPECIFICATIONS:

Voltage	220~240V
Power	7kw
Current	29.5 Amp
Circuit Breaker	32A
Recommend Wire	6 sq mm
Activate Water Flow	1.5/min
Inlet Pressure	0.02-0.6MPa
Overheat Temp	65°C
Thermal Cut-off	95°C
Water Connections	G1/2"



Touch Screen
LED digital Display



Overheat
protection

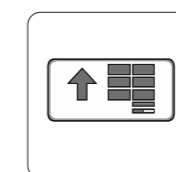

Trouble
code display



Thermal cutout

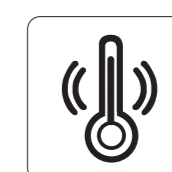

High-grade
Thermostat

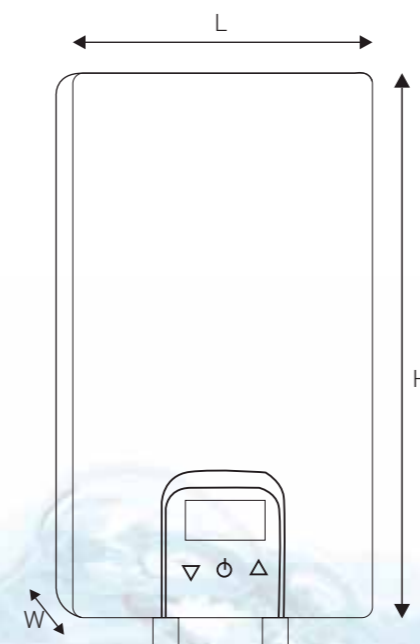

PRODUCTS DIMENSIONS

Model	Dimensions (mm)		
	L	W	H
Cuisiner	220	88	396



FRISSION

Digital Water Heater

FEATURES:

- Digital display system
- Temperature setting through remote control with timer facility
- Adjustable knob for temp. setting
- PUF insulation
- Incoloy glass coated heating element
- Magnesium Anode Rod
- **8 Bar pressure rating**
- Multi functional safety valve
- **5 Star Rating**

TECHNICAL SPECIFICATIONS:

Voltage	230V
Type	Storage
Frequency	50Hz
Wattage	2 Kilo Watts
Rated Pressure	8 Bar



Digital Display

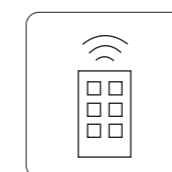

Wireless Remote Control

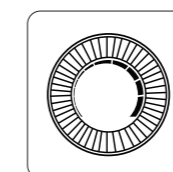

Adjustable knob for temp. setting

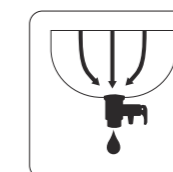

Multi Functional Safety valve



High-grade Thermostat

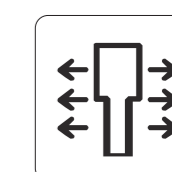

Magnesium Anode Rod



Digital Display



Adjustable knob

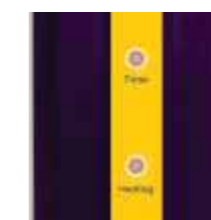

Timer & Heating



Remote Control

IS 2082:1993



CML/NO 9763707



BEE/RRE/0505/14



on electrical component



for tank

SUPREMIUS GLS

Vertical Mounting

FEATURES:

- Outer Body – ABS
- Safety feature – Multi functional valve, Thermostat, Thermal cutout
- Magnesium Anode Rod – to prevent corrosion on the heating element
- **Vitreous enameled coated tank**
- Analog temperature meter

TECHNICAL SPECIFICATIONS:

Voltage	230V
Type	Storage
Frequency	50Hz
Wattage	2 Kilo Watts
Rated Pressure	8 Bar

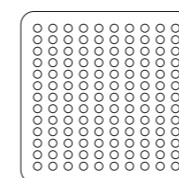

ABS Body



Multi Functional Safety valve



Thermal cutout

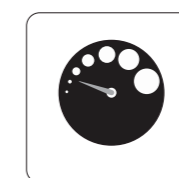

Analog Temperature Meter



High-grade Thermostat

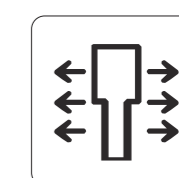

Magnesium Anode Rod

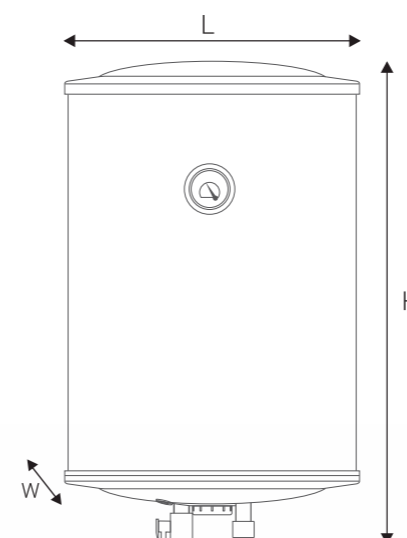

PRODUCTS DIMENSIONS

Capacity in Litres	Dimensions (mm)		
	L	W	H
6	325	340	415
10	325	340	475
15	325	325	550
25	370	370	630
35	431	450	650
50	431	450	700

Available in: 6, 10, 15, 25, 35 & 50 ltrs

Note: for 35 & 50 Ltrs the star rating is 3

IS 2082:1993



CML/NO 9763707



BEE/RRE/0505/14



on electrical component



for tank

SUPREMIUS GLS

Horizontal / Floor Mounting

FEATURES:

- Outer Body – ABS
- Safety feature – Multi functional valve, Thermostat, Thermal cutout
- Magnesium Anode Rod – to prevent corrosion on the heating element
- Vitreous enameled coated tank
- Also available in white / blue colour combinations

TECHNICAL SPECIFICATIONS:

Voltage	230V
Type	Storage
Frequency	50Hz
Wattage	2 Kilo Watts
Rated Pressure	8 Bar

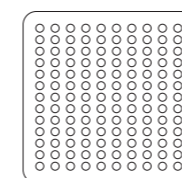

ABS Body

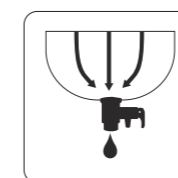

Multi Functional Safety valve



Thermal cutout



High-grade Thermostat

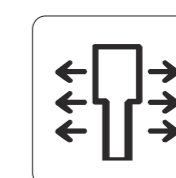

Magnesium Anode Rod

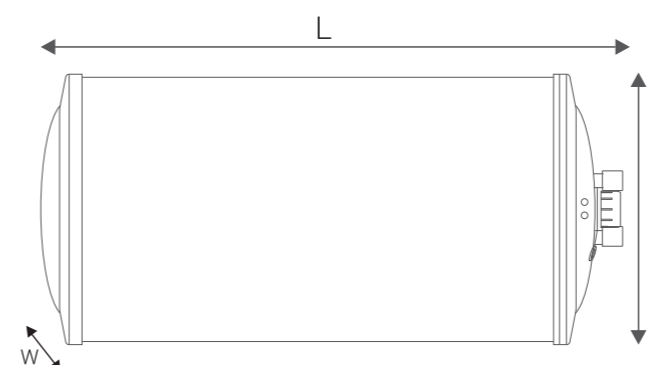

PRODUCTS DIMENSIONS

Capacity in Litres	Dimensions (mm)		
	L	W	H
10	475	340	325
15	550	325	325
25	900	340	325

Available in: 10, 15, 25, 35 & 50 ltrs

IS 2082:1993



CML/NO 9763707



BEE/RRE/0505/14



SUPREMIUS DLX

Vertical Mounting

FEATURES:

- External variable thermostat provided to save energy
- Safety feature – Multi functional valve, Thermostat, Thermal cutout
- Magnesium Anode Rod - to prevent corrosion on the heating element
- High grade & High gauge stainless steel tank - SS 304 L
- ABS outer body

TECHNICAL SPECIFICATIONS:

Voltage	230V
Type	Storage
Frequency	50Hz
Wattage	2 Kilo Watts
Rated Pressure	6.5 Bar

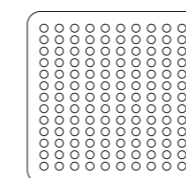

ABS Body

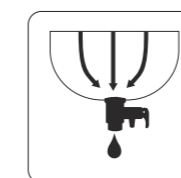

Multi Functional Safety valve



Thermal cutout



High-quality Thermostat

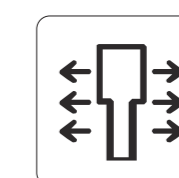

Magnesium Anode Rod

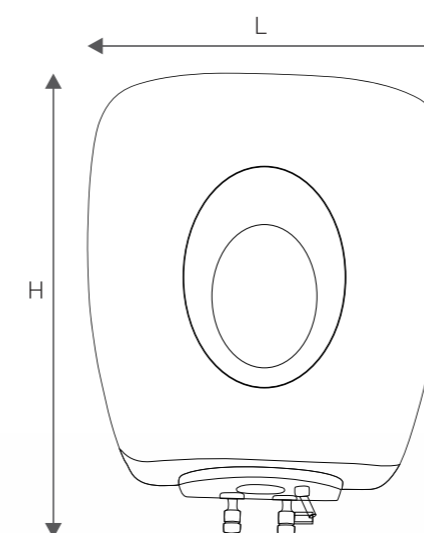

PRODUCTS DIMENSIONS

Parameters	6 ltrs	10 ltrs	15 ltrs	25 ltrs
Total Height	415	450	475	530
Outer Diameter	260	290	350	415
Leg to leg distance	110	200	225	230
Wall bracket slot distance	175	175	175	225

Available in : 6, 10, 15 & 25 ltrs

Available Colours : White Ivory

IS 2082:1993



BEE/RRE/0505/14



SUPREMUS

Vertical / Horizontal / Floor Mounting

FEATURES:

- Safety feature –
Thermostat & Thermal cutout
Pressure release valve & Fusible Plug
- High grade & High gauge stainless steel tank -
SS 304 L
- Anti vacuum system
- Rust proof powder coated body

TECHNICAL SPECIFICATIONS:

Voltage	230V
Type	Storage
Frequency	50Hz
Wattage	2 Kilo Watts
Rated Pressure	6.5 Bar



Thermal cutout



High-quality
Thermostat



Pressure
release valve

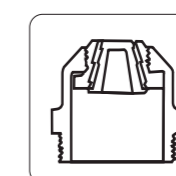

Fusible Plug

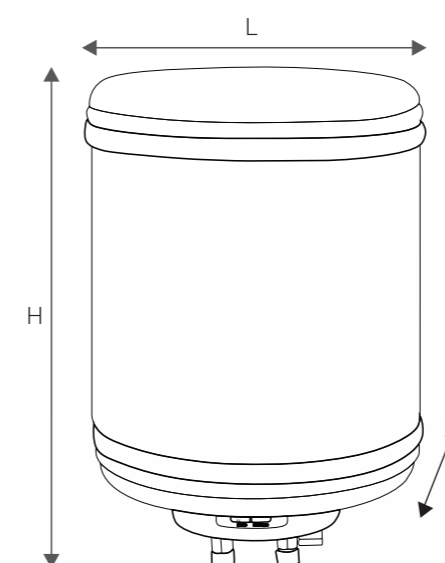

PRODUCTS DIMENSIONS

Capacity in Litres	Dimensions (mm)		
	L	W	H
6	325	255	415
10	405	255	510
15	395	305	495
25	432	380	540
35	457	380	635
50	457	380	740

Available in: 6, 10, 15, 25, 35 & 50 ltrs

Note: for 35 ltrs star rating is 3 and for 50 ltrs star rating is 2

IS 2082:1993



BEE/RRE/0505/14



on electrical
component



for tank



ARDOR

Instant Water Heater

FEATURES:

- Safety feature –
Thermostat & Thermal cutout
Pressure release valve & Fusible Plug
- High grade & High gauge stainless steel tank -
SS 304 L
- ABS outer body

TECHNICAL SPECIFICATIONS:

Voltage	230V
Type	Instant
Frequency	50Hz
Wattage	3 KW / 4.5 KW
Rated Pressure	6.5 Bar

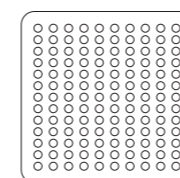

ABS Body



Thermal cutout



High-grade
Thermostat



Pressure
release valve

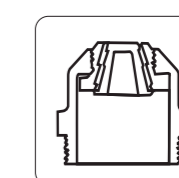

Fusible Plug

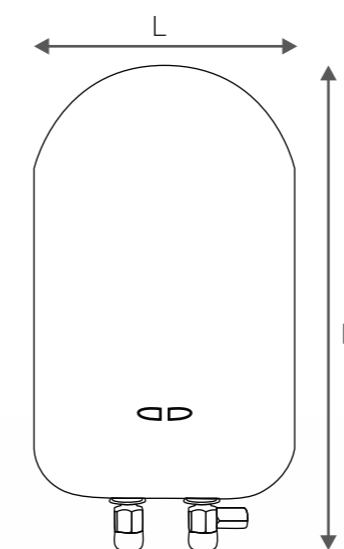

PRODUCTS DIMENSIONS

Capacity in Litres	Dimensions (mm)	
	H	L
1	330	170
3	370	210

Available in: 1, 3 ltrs

IS 2082:1993



INSTANT GAS

Water Heater

FEATURES:

- Most advanced IC ion sensor
- Water-gas linkage safety device
- Anti-blast device
- Ultra low pressure start up
- Over heating protection
- Back wind protection

TECHNICAL SPECIFICATIONS:

Type	Y: LPG T: PNG
Water Pressure	0.01-0.8 Mpa
Rated Heat Input	13 KW
Output Rate	6 L/min



IC ion Sensor

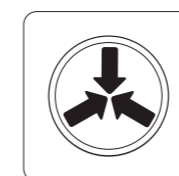

3-way temperature Control

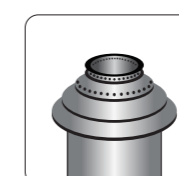

Stainless steel burners



Pressure release valve

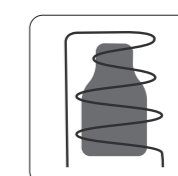

Heat exchanger technology

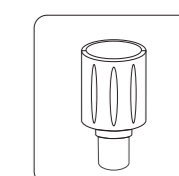

Provision for duct to exhaust flue gases.

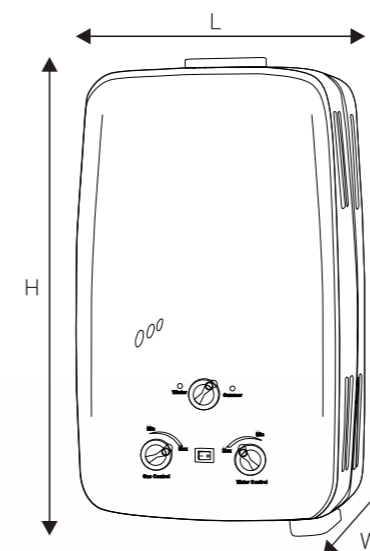

PRODUCTS DIMENSIONS

Capacity in Litres	Dimensions (mm)		
	L	W	H
6	305	168	535

Available in: 6 ltrs



HEAT CONVECTOR

Room Heater

FEATURES:

- Twin Turbo Design
- Two Heating Positions
- Thermostat & Thermal cutout
- Instant heating
- Portable

TECHNICAL SPECIFICATIONS:

Voltage	230V
Type	Room Heater
Frequency	50Hz
Wattage	2 Kilo Watts
Thermostat	Provided
Thermal cut-out	Provided
Heating position	1000W / 2000W

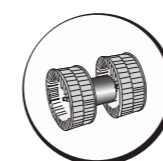

Turbo Blower

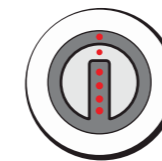

Temperature Control Knob

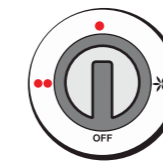

Dual Heat Setting

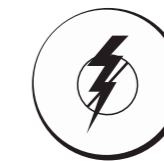

Thermal Cutout

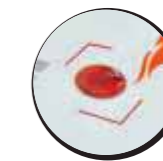

Indicator Light



Instant Heat



Two Heating Positions



Adjustable Heights



Indicator Light



Portable





AUTOMATIC ELECTRIC IRON

PLANATE

FEATURES:

- Automatic Electric Iron
- Dupont Non stick Coating
- Uniform Heating with Pressure Die cast sole plate
- Auto-off Pilot indicator
- Variable temperature control
- Ergonomic handle design
- Non stick coating



PLANATE



360 Swivel
Cord Movement



Thermal cutout



High-grade
Thermostat



Non-stick
coating



Uniform Heating
with Pressure
Die cast Soleplate



Auto-off
Pilot indicator



360° Swivel
Cord Movement



Ergonomic
Design



Teflon Classic Non
stick coating



AUTOMATIC ELECTRIC IRON

POWER GLIDE

FEATURES:

- Automatic Electric Iron
- Dupont Non stick Coating
- Uniform Heating with Pressure Die cast sole plate
- Auto-off Pilot indicator
- Variable temperature control
- Ergonomic handle design
- Non stick coating



360 Swivel
Cord Movement



Thermal cutout



High-grade
Thermostat



Non-stick
coating



Uniform Heating
with Pressure
Die cast Soleplate



Auto-off
Pilot indicator



360° Swivel
Cord Movement

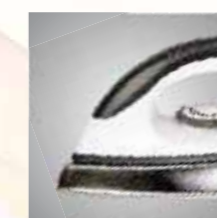

Ergonomic
Design



Teflon Classic Non
stick coating





AUTOMATIC ELECTRIC IRON

RR ELECTRIC

SILK FLOW

FEATURES:

- Automatic Electric Iron
- Dupont Non stick Coating
- Uniform Heating with Pressure Die cast sole plate
- Auto-off Pilot indicator
- Variable temperature control
- Ergonomic handle design
- Non stick coating



SILK FLOW



360 Swivel
Cord Movement



Thermal cutout



High-grade
Thermostat



Non-stick
coating



Uniform Heating
with Pressure
Die cast Soleplate



Auto-off
Pilot indicator



360° Swivel
Cord Movement



Ergonomic
Design



Non stick
coating

SAFETY

IS:302-2-3
CM/L-9653494

IS: 366

CM/L- 9653393

2
YEARS
WARRANTY

750
Watt



IMMERSION HEATER



1 KW / 1.5 KW / 2 KW

FEATURES:

- Shock proof handle - complete protection against electric shock
- Elegant Design
- Quick heating
- Water Level Indicator

TECHNICAL SPECIFICATIONS:

Voltage	230V
Type	Immersion Heater
Frequency	50Hz
Wattage	1.0 KW / 1.5 KW / 2.0KW



Shock Proof



Safe Heat

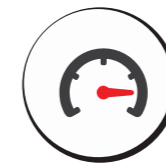

Long Life



Easy to use



1 KW



1.5 KW



2 KW



AIR COOLER

PERSONAL

FEATURES:

- Sturdy Design
- Blower motor
- Four way air deflection system
- Speed Control
- Uniform water distribution on pads
- Special honey comb pads
- Castors Wheel
- Water level indicator

TECHNICAL SPECIFICATIONS:

Voltage	230V
Frequency	50hz
Wattage	150 W
Warranty on Product	1 Year
Tank capacity	25 Ltrs
Air Throw	35 Ft
Air flow	3 Speed
Inverter Compatibility	Yes
Speed	1350 RPM

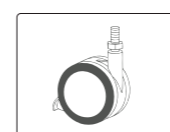

Castor Wheel



Auto Water Level Indicator

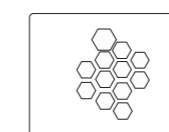

Honeycomb pad

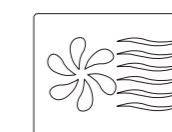

High Air Delivery

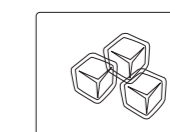

Ice Chamber

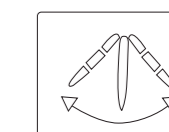

Swing

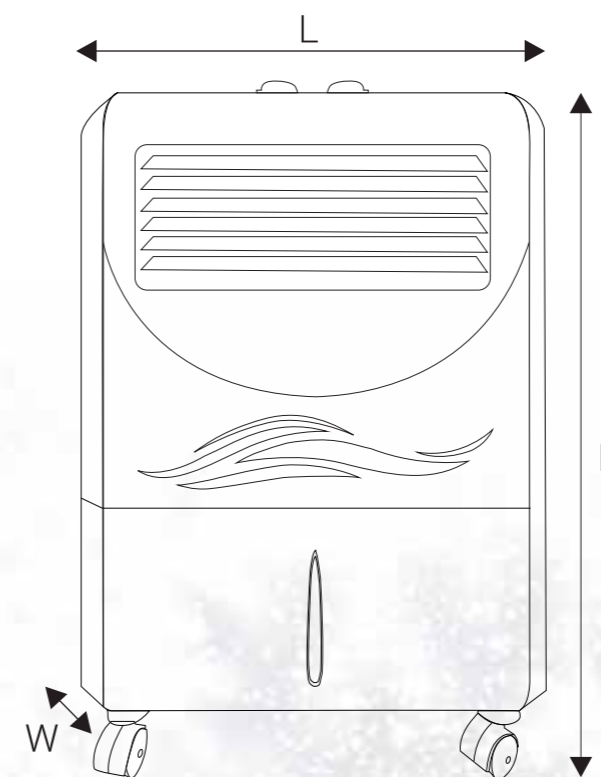

PRODUCTS DIMENSIONS

Capacity in Litres	Dimensions (mm)		
	L	W	H
25	325	460	740



AIR COOLER

TOWER COOLER



FEATURES:

- Sturdy Design
- Blower Motor
- Four way air deflection system
- Speed Control
- Uniform water distribution on pads
- Special honey comb pads
- Castors Wheel
- Water level indicator

TECHNICAL SPECIFICATIONS:

Voltage	230V
Frequency	50hz
Wattage	150 W
Warranty on Product	1 Year
Tank capacity	35 Ltrs
Air Throw	30 Ft
Air flow	3 Speed
Inverter Compatibility	Yes
Speed	1400 RPM

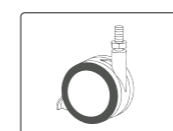

Castor Wheel



Auto Water Level Indicator

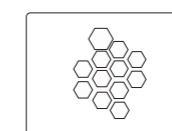

Honeycomb pad



High Air Delivery

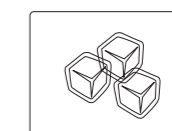

Ice Chamber

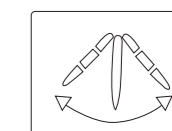

Swing

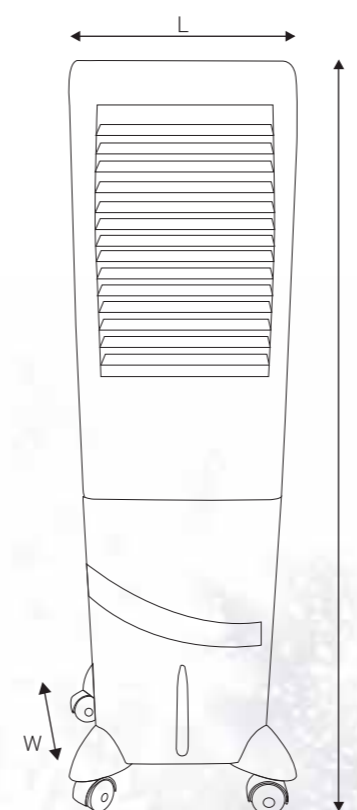

PRODUCTS DIMENSIONS

Capacity in Litres	Dimensions (mm)		
	L	W	H
35	320	320	1140



Fans range



LED Lighting range



RAM RATNA ELECTRICALS LTD.

Regd. Office :

305/A, Windsor Plaza, R. C. Dutt Road, Alkapuri, Vadodara - 390 007.

T : +91 - 265 - 2321 891 / 2 / 3 • F : +91 - 265 - 2321 894 • E : vadodara@rrglobal.in

Corp. Office :

Ram Ratna House, Oasis Complex, P. B. Marg, Worli, Mumbai - 400 013.

T : +91 - 22 - 2494 9009 / 2492 4144 • F : +91 - 22 - 2493 0203 • E : rrel@rrglobal.in

www.rrelectric.in

Customer Care Toll Free No: 18001032676

Service Co-ordinator: +91 9327553767 • Email: customercare@rrglobal.in

Terms & conditions apply. The products may differ as per catalog due to continuous improvements.
The colour shade of the Appliances shown may differ from the actual Appliances colour due to printing limitations.

Follow us on [f](#) | [in](#)